

**ROCK<sup>®</sup>  
DOOR**

**Style Secured.**

# CONTENTS

## ■ DOOR COLLECTIONS

Manhattan	4
Vogue	6
Vermont	10
Aspen	14
Hudson	16
Warwick	18
Jacobean	20
Newark	24
Astoria	28
Indiana	30
Dakota	32
Illinois	34
Portland	36
Carolina & Tennessee	38
Windsor	40
Colonial & Regency	42
Arcacia & Kentucky	44
Georgia & Montana	45
English Cottage	46
Cottage	48
Stable	50
French Doors	52
Double Doors	54
<b>Introducing the Dune</b>	<b>56</b>
Dune Vision	58
Dune Retreat	60

## ■ IT'S TIME TO CHOOSE

Door & Glass Designs	62-68
Backing Glass	69
Colours	70
Furniture	72-77
Thresholds & Drip Bars	78
Locks	79

## ■ FEATURES

Why Rockdoor is Different	80
Security & Performance	82-85



## REASSURINGLY ROCKDOOR

Since 1997, we've led the way in door design and development, blending an approach in which style and security are given equal importance.

It helps we have an obsession with doors and we've used this to continuously break the norm in the industry, whilst creating a name synonymous with quality.

We have amassed a unique collection of door styles and glass designs to suit the UK market. So, whether you have a traditional town house, a new build or a cottage style home, we've got you covered.

Throughout this brochure, we'll showcase you our door and glass styles, giving you peace of mind why Rockdoor is in a league of its own for style and security.





Manhattan - White - Misted Glass



## MANHATTAN

The aptly named Manhattan, is a hugely popular style at Rockdoor. This contemporary design features 5 delicately proportioned square glazing panels, which are lined through the centre of the door. All the glazing panels feature S-Glaze technology for the ultimate advance in security, meaning the glass is part of the door itself and not clipped in afterwards using a cassette.



Manhattan - Irish Oak - Curve Glass





## VOGUE

The Vogue is one of our most popular door styles and will certainly help you stand out from the crowd. It's perfectly suited to modern properties for an extra bit of flair, or even to create a bold statement on traditional homes, the Vogue truly is one of a kind.



3D  
GLASS

Vogue - White - Shade Glass



3D  
GLASS

Vogue - Anthracite Grey - Optima Glass



3D  
GLASS

Vogue - White - Haze Glass



3D  
GLASS

Vogue - Agate Grey - Cube Glass

The Cube (left) is one of our most popular glass styles for the Vogue and it's no wonder! This is thanks to its intricate level of privacy, created using a 3D glass design, striking the ultimate balance between privacy and style. We would recommend viewing this door style on our 3D designer to truly appreciate the effect of the Cube glass design.

The Shade glass design provides more than just a contemporary door style, it also adds an extra layer of privacy through a mixture of sandblasted and sandstone glass. But whichever Vogue you choose, we're sure you'll be delighted with it.





Vogue - White - Shade Glass

## VOGUE



Vogue - Anthracite Grey - Cube Glass



Vogue - Black - Ocean Glass





## VERMONT

Unique to Rockdoor, the contemporary Vermont suits a wide variety of properties thanks to its long narrow glass aperture and sophisticated moulding detail. Combine the Vermont with one of our stylish bar handles for a contemporary finish.



3D  
GLASS

Vermont - White - Haze Glass



3D  
GLASS

Vermont - Anthracite Grey - Continuity Glass



3D  
GLASS

Vermont - White - Shade Glass



3D  
GLASS

Vermont - White - Haze Glass

Its modern design makes it a firm favourite with homeowners around the country and looks fantastic in a wide range of colours from Pebble Grey through to Light Oak.

Selected with the Continuity glass design and you have one of Rockdoors best selling doors across the range.

Synonymous with style and flair, the Vermont truly captures the essence of Rockdoor in a stunning contemporary entrance door.





Vermont - Anthracite Grey - Shade Glass

## VERMONT



Vermont - Light Oak - Haze Glass



Vermont - Anthracite Grey - Grey Shades Glass



## ASPEN

An entirely new style for us, the Aspen brings something unique to the Rockdoor family.

Combining traditional vertical mouldings and a modern yet distinctive glazing panel, the Aspen is suitable for all lock types, giving you even more choice with this contemporary style, that doubles up as the perfect front or back door.



Aspen - White - Clear Glass



Aspen - White - Misted Glass





Hudson - White - Fade Glass



## HUDSON

Our newest door style called the Hudson, offers a luxurious and contemporary feel to any property. A central glazing panel that runs from top to bottom, is surrounded by matching moulding details for perfect aesthetics.

Of all the hundreds of unique glass designs we have launched over the years, we're pretty confident that 'Fade' will become a firm favourite. It's eye catching, delicate and intriguing all in one design.



Hudson - Pebble Grey - Fade Glass





## WARWICK

The Warwick is a versatile new door design from Rockdoor that looks just as good on a back door as it does a front door.

A stunning central glazing panel features in-between two moulding details from the top of the door, with three matching panels to the bottom.



Warwick - White - Clear Glass



Warwick - White - Reveal Glass



Warwick - Pebble Grey - Border Glass

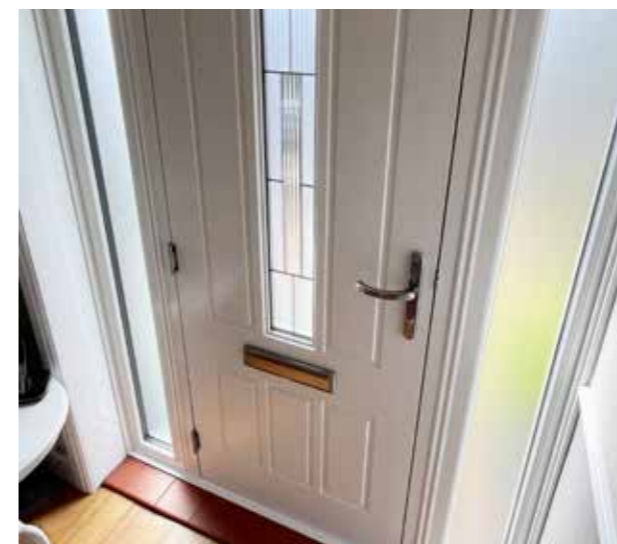

Warwick - White - Reveal Glass

Choose from our family of glass designs to suit this door style including the Shade and Border.

The Warwick can bring a traditional looking feel to any property, whilst it can also be used to complement a more contemporary styled home.





## JACOBEBAN

Simple yet stunning. The Jacobean is an incredibly versatile door style with two symmetrical glass panes running half way down the door, incorporating plenty of natural light into any home, creating a spectacular entrance for the front, back or even the side of your house!



Jacobean - Irish Oak - Empire Glass

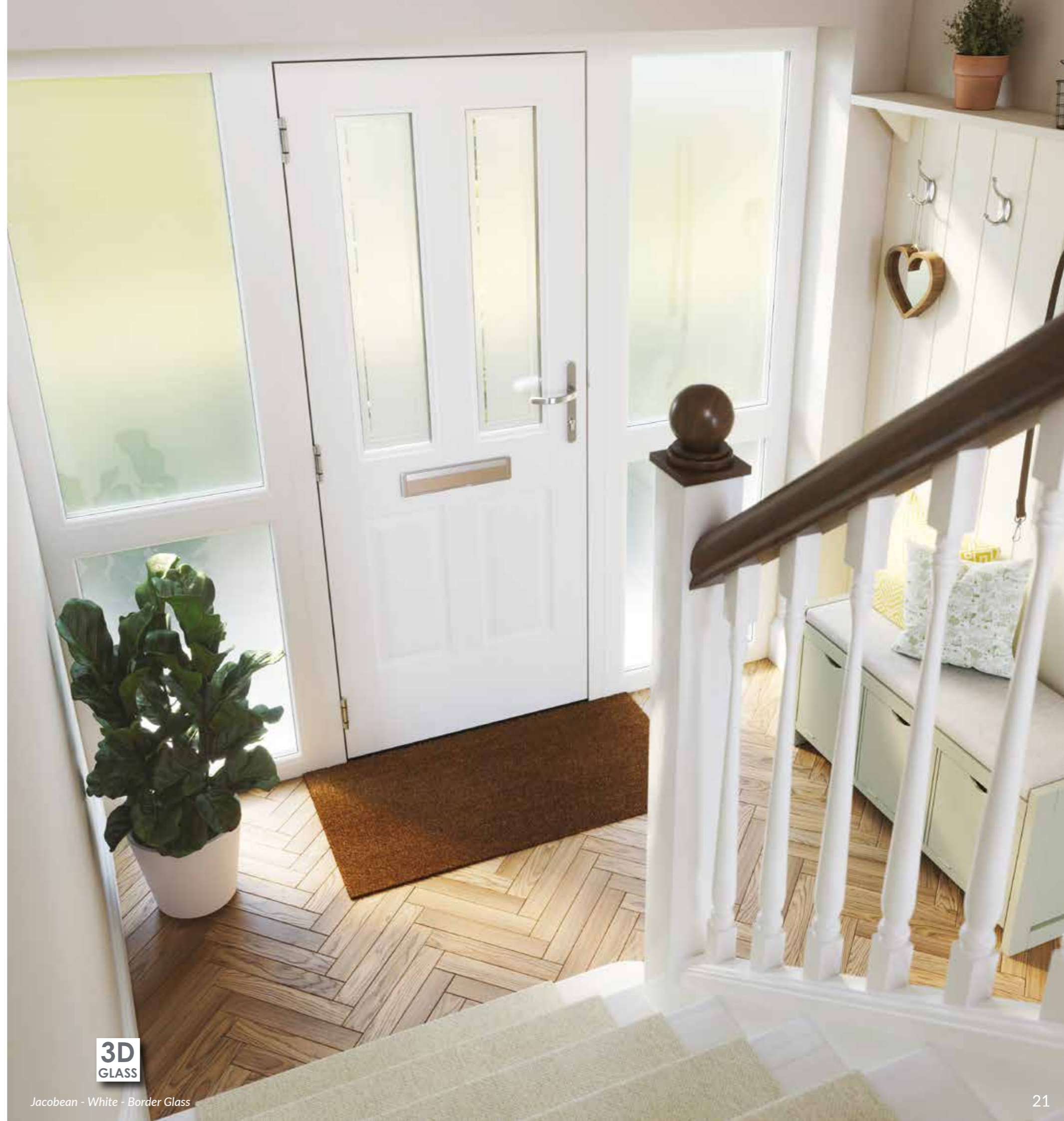

Jacobean - White - Border Glass





**3D**  
GLASS



*Jacobean - Chartwell Green - Inspire Glass*

## JACOBEAN

Combine this hugely popular door style with our Shade glass design for the ultimate contemporary finish. Another beautiful glass style that can be fully appreciated on our 3D door designer on [rockdoor.com](http://rockdoor.com) along with many more.



*Jacobean - Black - Apollo Glass*





## NEWARK

Old meets new in this modern take on a traditional style. The Newark's moulding lines blend classic design elements with contemporary manufacturing.

This is demonstrated by the Newark Jubilee (right), a traditional door style that will complement any property but also incorporates modern security details, including our burglar proof multi-point locking system, which is standard with every style.



Newark - Cream - Jubilee Glass

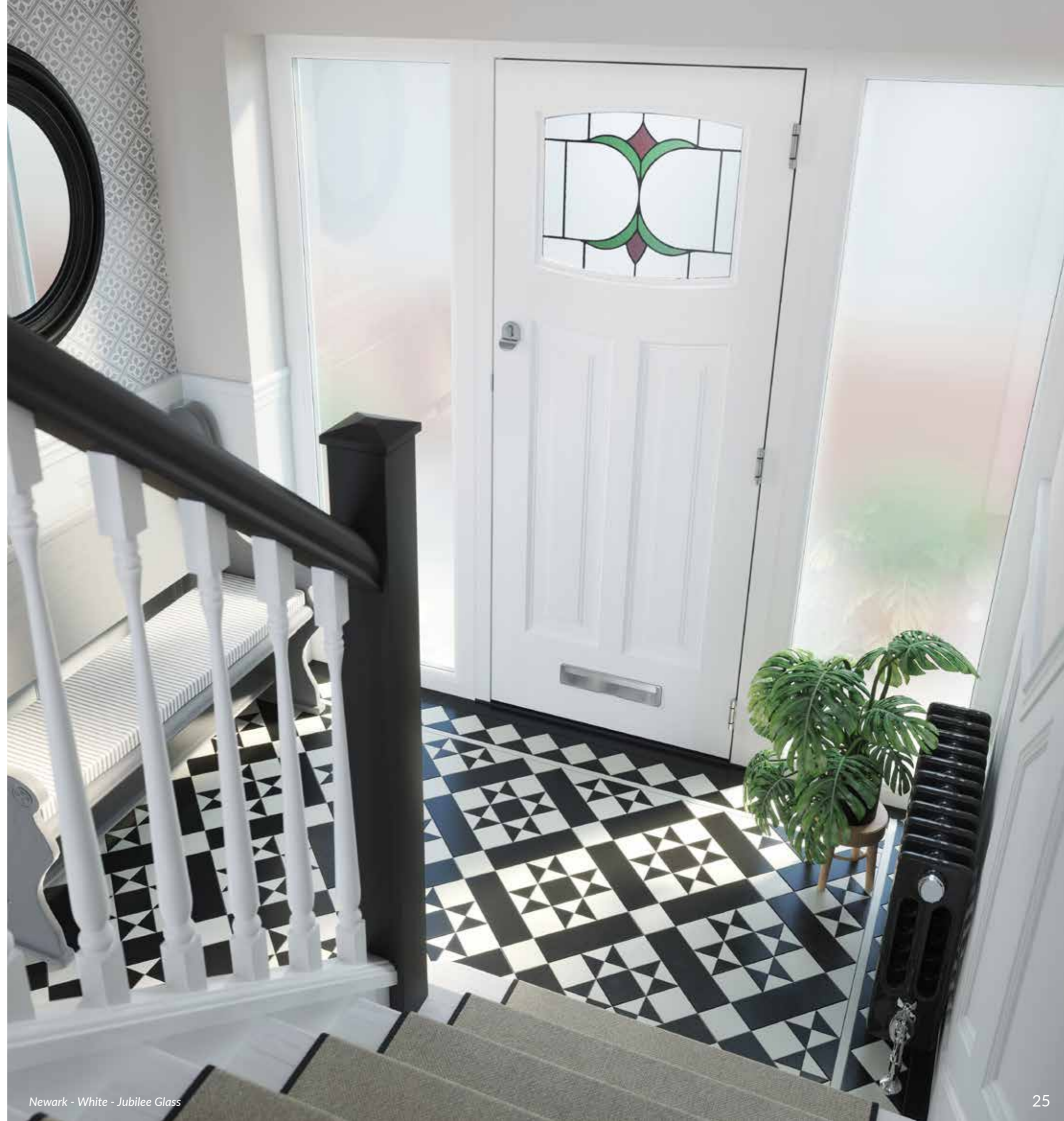

Newark - White - Jubilee Glass





**3D  
GLASS**  
Newark - Black - Iris Glass



Newark - White - Bright Star Glass

## NEWARK

Thanks to the traditional elements of the door, the Newark is the perfect family door for those looking to mix style with any setting and goes perfectly with our new Heritage Plus lock, which is available on the majority of our Rockdoor styles.



Newark - Black - Bright Star Glass





Astoria - White - Kensington Glass



## ASTORIA

The Astoria features a stunning crisp rectangular window at the top of the door with three stunning mouldings underneath, a 1930s classic that also suits modern homes.

Choose from traditional glass designs such as the Kensington, Green Shimmer and Grey Shimmer, all of which include a beautiful stained-glass design. Alternatively choose the Network design that features eight 3D rectangles for a more modern look.



Astoria - Chartwell - Green Shimmer





Indiana - Anthracite Grey



## INDIANA

The slick lines of the Indiana have made it one of the most popular styles that Rockdoor manufactures. When combined with a stainless steel bar handle, a knocker and a letterplate the results are phenomenal.

Solid doors can be paired perfectly with wire mesh reinforcing, for an optional but added extra touch of security. So, for a stylish, secure and energy efficient door, the Indiana fits the profile perfectly.



Indiana - Irish Oak





## DAKOTA

The Dakota's elegance is created using 4 square mouldings running down the centre of the door. Another solid door choice which excels in performance with wire mesh reinforcing, commonly used in conjunction with side panels, and often finished off with our bar handle range.



Dakota - Anthracite Grey



Dakota - White





## ILLINOIS

The Illinois is similar in style to one of our best-selling doors, the Jacobean, but features slightly longer glass apertures and a delicate swept head.

Choose from 3 stunning glass designs shown here, or even sandblasted glass for a contemporary finish.



*Illinois - Irish Oak - Empire Glass*

*Illinois - Light Oak - Pinnacle Glass*





Portland - White - Beacon Glass



## PORTLAND

If your priority is letting light in, look no further than the Portland. As well as the security of S-Glaze glass, you've the option of ornate glass bevels and stunning gluechip glass to provide an astounding combination of both traditional and contemporary.

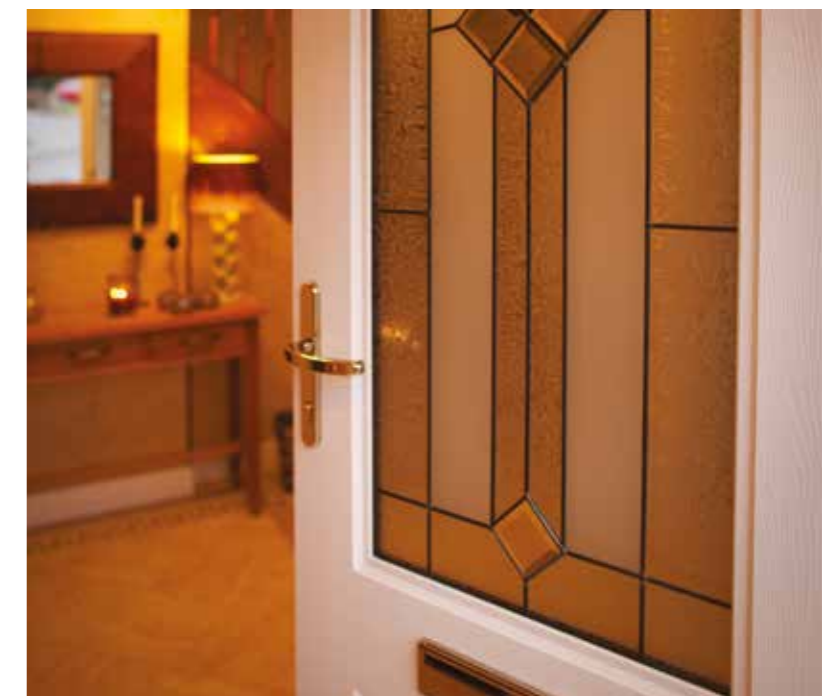

Portland - White - Beacon Glass





## CAROLINA & TENNESSEE

Similar in style, the Carolina and Tennessee are popular door styles for homeowners looking for a traditional effect entrance door. The Carolina features a Georgian look and feel to the glazing aperture and provides high levels of privacy, whereas the Tennessee lets in more light and is available with a wide range of glass designs.



Tennessee - Chartwell Green - Crystal Bevel Glass



Carolina - White - Misted Glass





## WINDSOR

The Windsor features a large rectangular glazing aperture to incorporate natural light into any home, which can be perfectly combined with a low aluminium threshold for easy kitchen and laminate floor entrances.



Windsor - Ruby Red - Linear Glass



Windsor - White - Clear Glass





## COLONIAL & REGENCY

The Colonial and Regency are both intricately designed, perfect for those conscious of privacy but still wanting a traditional style of door.



Colonial - Anthracite Grey

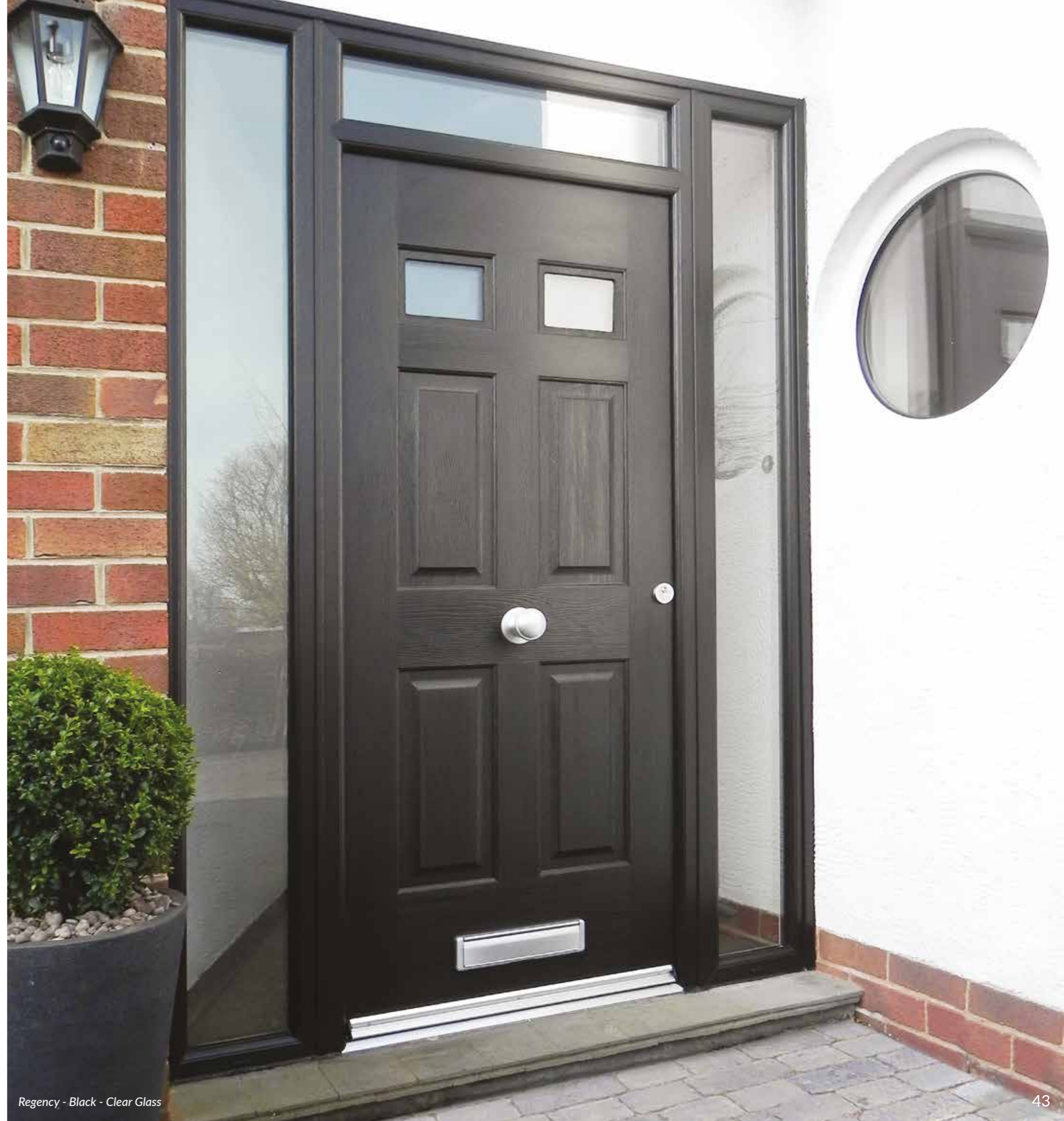

Regency - Black - Clear Glass





## ARCACIA & KENTUCKY

Go traditional with the Arcacia door style, which has over recent years been a firm favourite amongst Rockdoor customers thanks to its timber effect appearance. Much like the Kentucky which features a large arched piece of glazing to allow natural light to enter any home.



Arcacia - Irish Oak - Summit Glass



## GEORGIA & MONTANA

Almost identical by the mouldings, the Georgia features a larger pane of glass, complemented by traditional curved panels. The Montana contains a smaller, oval shaped piece of glass to fully highlight the elegance in the design surrounding it.



Georgia - Black - Clear Glass





English Cottage - Agate Grey - Clear Glass



## ENGLISH COTTAGE

A classic door that has constantly retained its popularity. The English Cottage features a narrow mid rail and a curved top moulding detail to complement a perfectly sized piece of glass that all works collectively to create a truly beautiful entrance door.



English Cottage - Light Oak - Rectangular Leaded Glass





## COTTAGE (SPY & VIEW LIGHT)

The Spy View features a deep mid rail alongside a straight top moulding detail and the aptly named pane of glass. The View Light replaces the top mouldings with a larger glass unit, flooding natural light into any home.



Cottage Spy - Black - Gluechip Glass



Cottage Spy - White - Clear Glass





## STABLE (VIEW LIGHT & SPY)

Stable doors add charm and convenience, so it's no surprise that they're such a firm favourite. They allow the outside into any home by acting as both a door and a window.



Stable View Light - White - Clear Glass



Stable Spy - White - Misted Glass



Stable View Light - White - Clear Glass



Stable View Light - Light Oak - Clear Glass

## PRACTICAL

A slide bolt allows you to operate the top of the door independently of the bottom of the door, helping you bring the outside in. It's also a great way to keep pets inside whilst letting fresh air in.

## UNIQUE & SECURE

Our tried and tested custom-made centre seal ensures the door acts as one so you don't have to worry about leaks. Stable door locks are just as strong as our other doors and feature specially made multipoint locks with two strong deadbolts and two hooks, both top and bottom, to keep you secure.





## FRENCH DOORS

Rockdoor French Doors were the first in the industry to achieve the Secured by Design accreditation for safety and security, which means you don't have to compromise on safety.

Multipoint locks, deadbolts and high security hinges are combined with shoot bolts which engage into the top and bottom of the outerframe for total security.



French doors are available as a single door, the Classic.



Classic French - White - Clear Glass





## DOUBLE DOORS

Double the style to create a stunning first impression, with Rockdoor Double Doors. Nearly all of our door styles can be made into a double door for the ultimate entrance. Please speak to your installer for more details.



Vermont Double - Black - Grey Shades Glass



Vermont Double - Irish Oak - Clear Glass



Vogue Double - Rosewood - Optima Glass





## INTRODUCING THE DUNE

For years, composite doors have tried to replicate timber doors. Ultimately, woodgrain doesn't always suit modern doors. This led Rockdoor to design a new texture called the Dune, designed with contemporary homes in mind.

Our industry first door texture completely rips up the composite door rule book to create a stunning, ultra-modern look, reminiscent of sand dunes.

The unique texture runs from the sides of the door towards the glazing aperture, where it cleanly falls away into the glass to form a perfect seal.

Exclusive to **ROCKDOOR**.





## DUNE VISION

With a tall glass aperture running almost the entire length of the door, the Dune Vision is designed to not only look breath-taking, but to flood copious amounts of light into any hallway, allowing homeowners to create a fresh, bright and welcoming entrance.



*Dune Vision - White - Misted Glass*

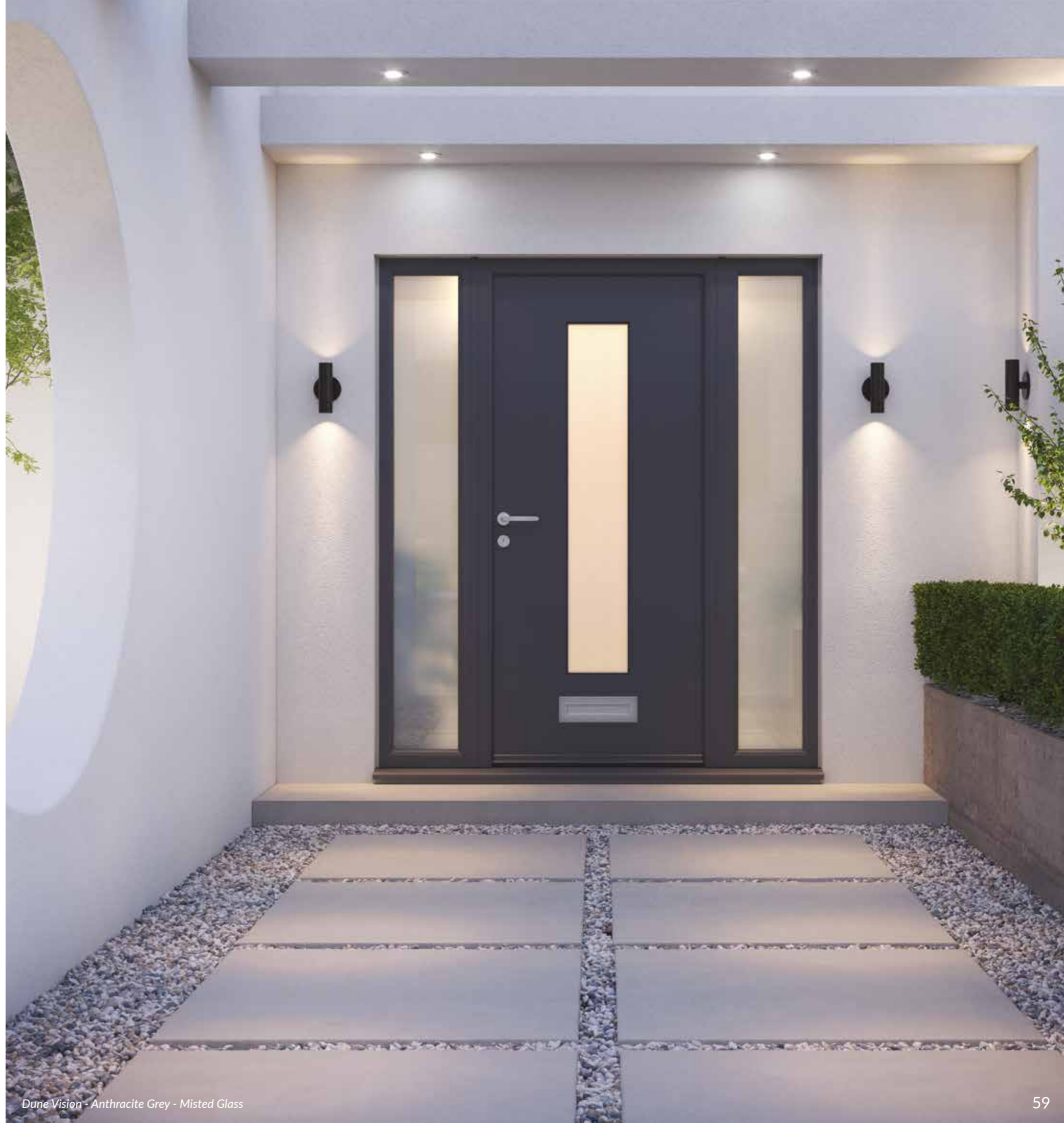

*Dune Vision - Anthracite Grey - Misted Glass*





Dune Retreat - White - Misted Glass



## DUNE RETREAT

For homeowners looking for a door with contemporary style whilst retaining a level of privacy, then the Dune Retreat is unmatched. Featuring an ultra-slender glass aperture little over 100mm wide, this door can be matched with Reeded glass, providing a glazing pattern that runs perpendicular to the door texture to create a stylish combination.



Dune Retreat - White - Misted Glass



# IT'S TIME TO CHOOSE!



## The Original Composite Door

The following pages show the full range of glass designs available. We are also pleased to offer Georgian bars, as well as Square or Diamond lead patterns.

The majority of our glass designs are displayed with either a Gluechip or Sandstone backing glass for privacy, so please consult your installer for further information to avoid ordering the wrong combination.

3D glass designs do not require a backing glass, as the pattern to create the 3D effect means both the front and back piece of glazing features a pattern.



### VERMONT

PAGES 10-13



Shade

Continuity

Haze

Quadra

Grey Shades

Trio



### MANHATTAN

PAGES 4-5



Clear Glass

Curve

Sandstone

Misted



### NEWARK

PAGES 24-27



Clear Glass

Iris

Lantern\*

Bright Star

Citadel\*

Jubilee



### ASTORIA

PAGES 28-29



Kensington

Network

Grey Shimmer

Green Shimmer

North Star





HUDSON

PAGES 16-17



Clear



Haze



Fade



Shade



Grey Shades



WARWICK

PAGES 18-19



Clear



Border



Haze



Reveal



Shade

The Reveal is backed with Reeded Glass



VOGUE

PAGES 6-9



Clear



Shade



Fluid



Optima



Haze



Archer



Ocean



Cube



Abyss



DUNE VISION

PAGES 58-59



Clear Glass



Reeded Glass



DUNE RETREAT

PAGES 60-61



Clear Glass



Reeded Glass



ASPEN

PAGES 14-15



Clear Glass



Shade



Border



Reeded



JACOBEOAN

PAGES 20-23



Empire\*



Border



Shade



Fluid



Scorpio\*



Apollo\*



Inspire\*



Summit



Linear



Crystal Bevel





CAROLINA

PAGES 38-39



Clear Glass



Clear Glass



CLASSIC

PAGES 52-53



Clear Glass



Clear Glass



WINDSOR

PAGES 40-41



Triton\*



Titania\*



Summit



Ellipse



Linear



Crystal Bevel



TENNESSEE

PAGES 38-39



Clear Glass



Dorado\*



Summit



Ellipse



Linear



Crystal Bevel



KENTUCKY

PAGE 44



Linear



Aquarius\*



Summit



Ellipse



Crystal Bevel



ILLINOIS

PAGES 34-35



Clear Glass



Kudos\*



Trinity\*



Pinnacle\*



Empire\*



Inspire\*



GEORGIA

PAGE 45



Clear Glass



Northern Star\*



MONTANA

PAGE 45



Libra\*



Renaissance\*



PORTLAND

PAGES 36-37



Clear Glass



Beacon\*



Horizon



Apostle\*



ARCACIA

PAGE 44



Ellipse



Cosmopolitan\*



Summit



Crystal Bevel





INDIANA

PAGES 30-31



DAKOTA

PAGES 32-33



REGENCY

PAGES 42-43



Clear Glass

Clear Glass



COLONIAL

PAGES 42-43



ENGLISH COTTAGE

PAGES 46-47



Clear Glass

Square Lead



COTTAGE SPY VIEW

PAGES 48-49



Clear Glass

Clear Glass



COTTAGE VIEW LIGHT

PAGES 48-49



Clear Glass

Clear Glass



STABLE DOORS (Spy, View Light)

PAGES 50-51



Spy View

View Light

# BACKING GLASS

All Rockdoor glass comes double glazed at the very minimum, which means your backing glass can have a big affect on your Door Set Energy Rating (DSER). Choosing an obscure backing glass provides greater privacy for your home, however choosing it in place of clear glass will reduce the DSER.



SANDSTONE

Sandstone is a versatile and popular obscure backing glass that features on many glass designs shown throughout this brochure to show off the glass design. So please make sure you choose this option for privacy as and where needed.



GLUECHIP (Random pattern)

Gluechip glass is available as an obscure backing glass. Gluechip also features on many glass designs through this brochure, so where Gluechip is present in the actual glass design, we recommend just using clear glass as the backing glass choice.

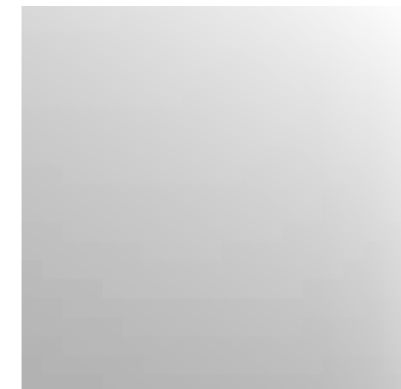

CLEAR

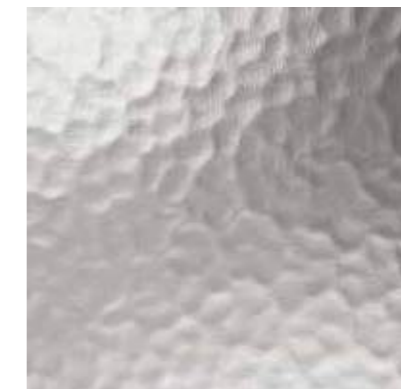

HONEYCOMB



GLACIER

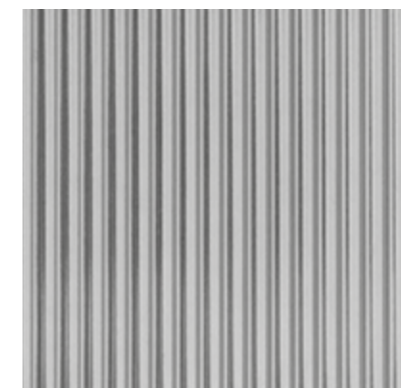

REEDED

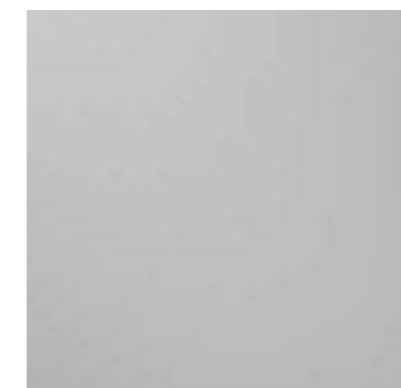

MISTED



WOODLAND



# EYE CATCHING COLOURS



**WHITE**  
Available with matching outerframe.



**AGATE GREY (RAL7038)**  
Available with matching outerframe.



**PEBBLE GREY (RAL7032)**  
Available with matching outerframe.



**CREAM (RAL9001)**  
Available with matching outerframe.



**SLATE GREY (RAL7015)**  
Available with matching outerframe.



**IRISH OAK**  
Available with matching outerframe.



**LIGHT OAK**  
Available with matching outerframe.



**ROSEWOOD**  
Available with matching outerframe.



**ANTHRACITE GREY (RAL7016)**  
Available with matching outerframe.



**CHARTWELL GREEN**  
Available with matching outerframe.



**EMERALD GREEN (RAL6009)**



**SAPPHIRE BLUE (RAL5011)**



**BLACK (RAL8022)**  
Available with matching outerframe.



**RUBY RED (RAL3011)**

Rockdoors are available in 14 colours so you can choose what's right for you. Each colour features a texture to give the appearance of a timber door, excluding the Dune which features a horizontal pattern.

As Rockdoors are made to order and not cut to size, all colours are available inside and out.

Our door colours are foiled which means no flaking or fading paint which is common on other doors.

Please check our colour swatch before ordering, or use our 3D door visualiser at [Rockdoor.com](https://www.rockdoor.com).



# CLASSIC FURNITURE

All our classic furniture range comes with an installer backed guarantee, so not only does it perform as good as it looks, but be rest assured that the quality of our products are bound to last alongside your new Rockdoor.



## ADDITIONAL FURNITURE



VICTORIAN CENTRE KNOB



URN KNOCKER WITH/WITHOUT SPY HOLE



STANDARD NUMERALS



ARCHITECTURAL KNOCKER



## LETTERPLATE

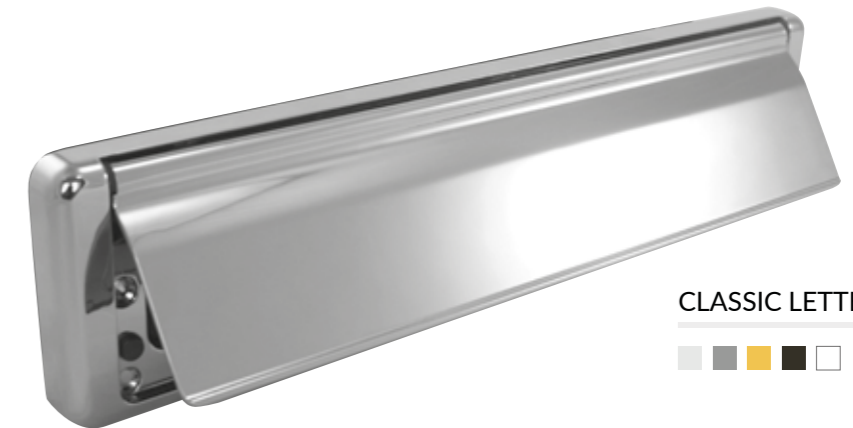

CLASSIC LETTERPLATE



## LEVER HANDLES



ESCUTCHEON



LEVER/LEVER



LEVER/PAD



### COLOUR KEY



## WROUGHT IRON

For the ultimate, victorian charm, complete your Rockdoor with one of our expertly crafted Wrought Iron handles. These handles look incredible on wooden coloured doors.



ARCHED LEVER



TWISTED LEVER



# STAINLESS FURNITURE

Crafted using high grade Stainless Steel, all furniture in this section is perfect for longevity, especially if you live near the coast.

Available colour options for each item are listed individually.



## LEVER HANDLES & DOOR PULLS



Satin



Black

### ESCUTCHEON



Satin



Polished



Black



Gold

### FINGER PULL



### LEVER/LEVER

Satin



### CURVED ROSE

Satin



### EUROPEAN ROSE

Satin

## LETTERPLATES

### ROUNDED LETTERPLATE



Satin

### CONTEMPORARY LETTERPLATE



Satin

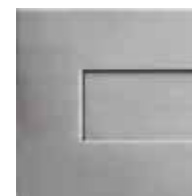

Satin



Polished



Black



Gold

## ADDITIONAL FURNITURE



Satin

### BULL RING KNOCKERS



Satin



Polished



Black



Gold



### SQUARE CENTRE KNOB

Satin



### CONTEMPORARY KNOCKER

Satin



### CONTEMPORARY NUMERALS

Satin



# BAR HANDLES

Our bar handle range all offer a stunning satin, yet bold statement to truly complement any contemporary style of Rockdoor.

Manufactured from the same top-quality product as our Stainless Steel range, all our bar handles come with a key lock and switch latch as standard. The lock can be upgraded to an instant lock.



ROUND BAR 1200mm



ROUND BAR 900mm



ROUND BAR 600mm

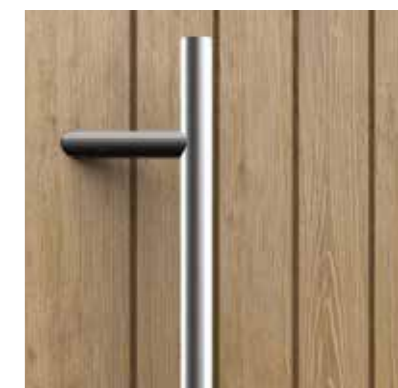

ROUND OFFSET BAR 1200mm



SQUARE BAR 1200mm



SQUARE OFFSET BAR 1200mm



SQUARE BAR BLACK 900mm



MITRED BAR 900mm



## THRESHOLDS & DRIP BARS EXPLAINED

### LOW ALUMINIUM THRESHOLD

Aluminium threshold with a height of 15mm and available in gold or silver.

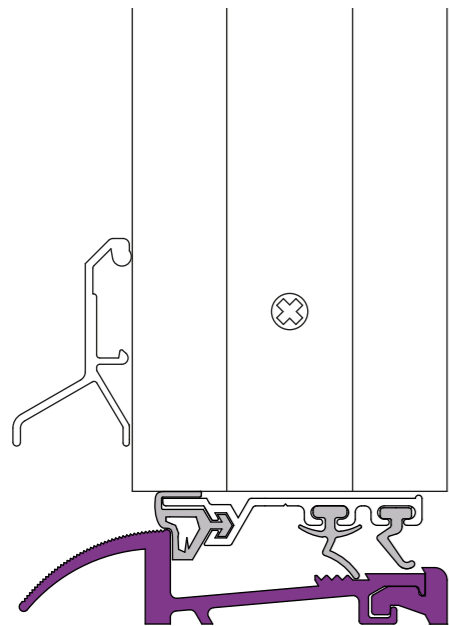

Drip bars can match the furniture or the door colour.

- Good thermal performance
- Very durable
- Suitable for wheelchair access

### PVC THRESHOLD (SLIM & FULL)

PVC-U threshold available in two heights 52mm and 72mm. The colour matches the door frame.

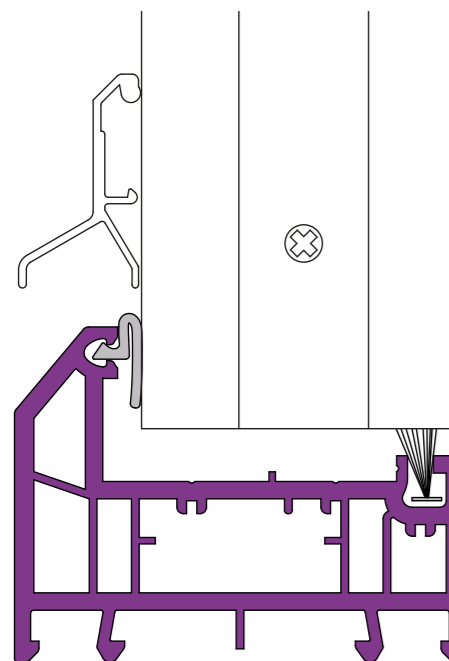

Drip bars can match the furniture or the door colour.

- Maximum thermal performance
- Works great on carpeted entrances
- 52mm provides easy access

## LOCKS EXPLAINED

### LEVER

- Once the handle is raised, the shootbolt and hook locks are thrown into the door frame. The door is then secured with a simple turn of the key or thumbturn lock.
- The force of raising the handle also pulls the door into the frame, ensuring compression between the frame and door sash on the seals.
- Available with lever/lever and lever/pad handles.

### KEY

- To lock the door, a slight compression is needed by manually pushing the door into the frame and against the door seals.
- Then a keywind lock, or keywind 'thumbturn' lock, is needed to manually turn the lock to engage the deadbolt and hooks and secure into the outerframe.

### INSTANT

- There is no need to manually lock the door with a key. It's locked automatically when magnets detect the door has been closed. This then throws the deadbolt and hook locks into the outerframe securing the door.
- Compression between the door and the frame of an instant lock isn't comparable to either handle or key operated locks, which achieve a better seal overall.

Switch latch feature comes as standard with key lock & instant lock.



#### NO ACCESS

When the switch is in the up position, a key is required for access.

#### ACCESS

When the switch is in the down position, the door can easily be pushed open.

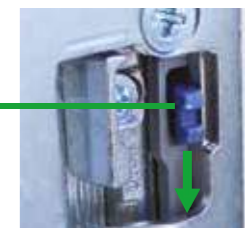



## WHY ROCKDOOR IS DIFFERENT

### ■ HOOKS

Steel hooks with a 25mm throw engage into the reinforced outer frame.

### ■ ENGINEERED INNER FRAME

A welded and reinforced door skeleton is impervious to moisture ensuring it won't swell or rot.

### ■ REINFORCED FRAME

Rockdoor's inner frame is reinforced with aluminium making it the strongest door frame on the market.

### ■ CYLINDER

3 star diamond sold secure cylinders prevent forced attack.

### ■ DEADBOLT

Secures the sash to the outer frame acting as part of the multipoint lock.

### ■ HIGH DENSITY CORE

60% stronger core than a standard composite door.

### MADE TO MEASURE

All our doors are made to measure and not cut to fit. Standard composite doors are cut to fit which weakens the door overall.



It's important to know what goes on under the surface of a Rockdoor, as this is what makes our door so strong and secure.

### ■ S-GLAZING

No cassettes eliminate glass removal, ensuring a perfect colour match and no air or water leakage. All our glass is toughened as standard.

### ■ STEEL SECURITY MESH

Make your door 4 times stronger and impossible to cut through with steel security mesh.

### ■ OUTER FRAME

PVC-U multi-chambered, insulated outer frame for high levels of thermal performance and strength.

### ■ STEEL KEEPS

Steel hook locks engage into full length steel keeps preventing forced entry.

### ■ HINGES

Engineered 3 way adjustable hinges secured into the reinforced frame for extra strength.

### ■ HIGH IMPACT DOOR SKINS

Thick and tough 3mm PVC-U door skins both internally and externally resist cutting and impacts.



Style Secured



## UNRIVALLED CONSTRUCTION

- **UNIQUE TO ROCKDOOR**  
The way a Rockdoor is designed and manufactured is what makes us stand out from the crowd.
- **STEEL SECURITY MESH**  
For total security, upgrade to Steel Security Mesh reinforcing which is unique to Rockdoor.
- **STRONG INTERNAL STRUCTURE**  
The inner frame of a Rockdoor is fully reinforced with a 360° Aluminium box section that makes the door super strong.

## BURGLAR PROOF MULTIPOINT LOCKS

70% of burglaries involve forced entry through the front or back door. Back doors in particular are vulnerable as they are often out of sight, so a strong and secure Rockdoor front and back is important.

- **MULTIPOINT HOOKS**  
Our steel hooks slide into steel keeps that run the full length of the outer frame.
- **DEADBOLT**  
Our deadbolt engages into the centre of the door frame for maximum strength.
- **GEARBOX**  
Our multipoint lock gearboxes ensure smooth lock functionality.



PROTECTING HOMES SINCE  
**1997**



In fact, it's so hard to break through a Rockdoor that the Fire Service regularly visit our manufacturing facility for training on how to do so in the rare event of an emergency.

## IMPOSSIBLE TO CUT THROUGH

Steel Security Mesh within a Rockdoor makes it impossible to cut through by a burglar. It is similar to the way concrete is reinforced for extra strength. *Please ask your installer about this optional extra.*



**Can you really afford to settle for anything less?**



## ROCKDOOR S-GLAZE

### EXCLUSIVELY FROM ROCKDOOR

All Rockdoors feature our unique S-Glaze technology. This means the glass is locked in for life.

This prevents forced entry through the glass as there is no glazing cassette to attack, whilst also eliminating draughts through the glazing apertures which improves the door's thermal performance.

#### ■ ZERO FADING

Glazing cassettes which are widely used on standard composite doors, are prone to fading and discolouration.

#### ■ LAMINATED GLASS

Whilst all our glass is toughened, we do offer customers who feel vulnerable the option to upgrade to laminated glass, often in accordance with Secured by Design. Laminated glass is two pieces of glass with a plastic inner film like a car windscreen.

## THERMAL PERFORMANCE

Like your safety, your energy bills are in good hands. A combination of material choices such as PVC-U and a 50mm thick high density polyurethane core and unique manufacturing techniques such as S-Glaze Technology, allow Rockdoor to produce good thermal ratings.

## REASSURINGLY SECURE



It's reassuring to read about Rockdoors security features. But we know what matters most as you lock up your home is that the only way to get past your Rockdoor is with your key.

That's why Rockdoors come with a 3 star security rating – the best there is.

#### ■ SOLD SECURE

Sold secure diamond status - SS 312 Master Locksmith Association's highest possible rating.

#### ■ LOCK DOWN MODE

Our cylinders are designed to go into 'lock down mode' if the attempt of forced entry is detected.

#### ■ ANTI-SNAPPING PROTECTION

Designed to snap away if attacked, shutting down the mechanism to prevent access.

#### ■ ANTI-DRILL PROTECTION

Our cylinder features a solid cam which is made of Molybdenum, which is stronger than steel.

**£2,000**  
GUARANTEE



We are so confident that our lock cylinders are resistant to forced entry, that we offer a £2,000 lock guarantee. See our website for further details.

A



## FEATURES & BENEFITS

With over 25 years of manufacturing history, Rockdoor are consistently at the forefront of innovation with new ideas, leading the way in terms of composite door security, thermal efficiency, and style.

Most of the foundations that Rockdoor were built are still seen today in our fantastic range of entrance doors, however over the years we have had to adjust where possible in order to stay ahead of the game, to give homeowners the best composite door available.

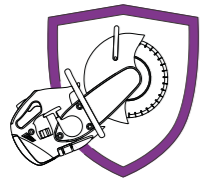

### Forced Entry

For almost 30 years, we have led the way to ensure our doors protect homes and families from unwanted intruders and forced entry.



### Hook up with Rockdoor

Steel multipoint hook locks securely attach the door to the outer frame to ensure it cannot be forcibly opened, whilst ensuring a better sound and weatherproof seal.

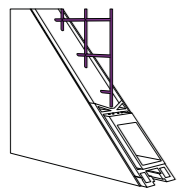

### Core Benefits

Our inner strength is unsurpassed thanks to a combination of a 360° aluminium reinforced inner frame and high-density thermally efficient PU foam.



### Glass Leading Security

Rockdoors feature S-Glaze technology, which means your glass is locked into your door for life, for added security. It also means no fading glazing cassettes.

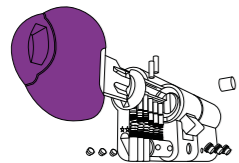

### £2,000 Guarantee

Our 3 star lock cylinders come with a £2,000 security guarantee as we are that confident they can't be picked, drilled, bumped or snapped.



### Stronger, It's Official

Rockdoor is one of the most secure doors available in the UK, studies show that a Rockdoor is 35% stronger than a typical GRP door.



## Need some inspiration?

### ■ CHECK OUT OUR 3D DOOR DESIGNER

You can now design and place your dream door right onto an image of your home, all in high-quality, 3D resolution – a very unique perspective to help you visualise how your door will truly look on your home.

### ■ VISIT OUR DOOR GALLERY

Struggling to decide on a style? Or maybe you can't narrow it down to a colour? Check out our extensive door gallery on Rockdoor.com to see what others have gone for, so you can make the right decision for your home.

### ■ HEAD TO OUR SOCIAL MEDIA

We are always active on Instagram, Facebook, X and TikTok – so you can keep up to date with what's currently trending!



Find us @RockdoorLtd

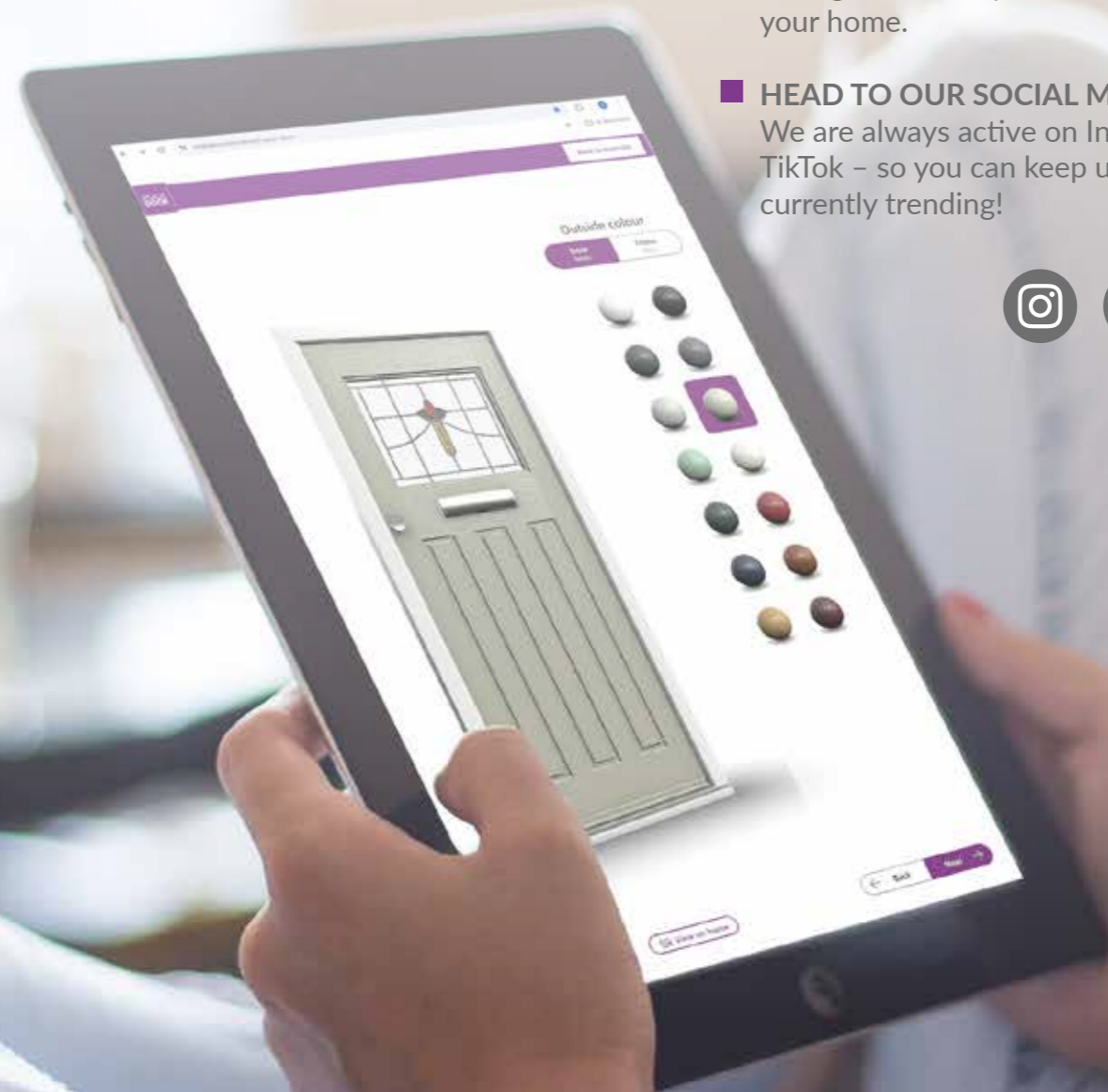

# unleash your creativity

Design the perfect door to suit your home at [Rockdoor.com/design-your-door](https://www.rockdoor.com/design-your-door)





# The Original Composite Door.

Established **1997**



[rockdoor.com](https://rockdoor.com)



All photographs, colours, and images are to be considered representative of the actual products. We reserve the right to change specifications at any time. Please check energy ratings before ordering. Furniture positioning is dependent on door style and sizes. All images copyright to Rockdoor Ltd. Rockdoor is a registered trademark. July 2024.